

# THETA DIGITAL

C O R P O R A T I O N

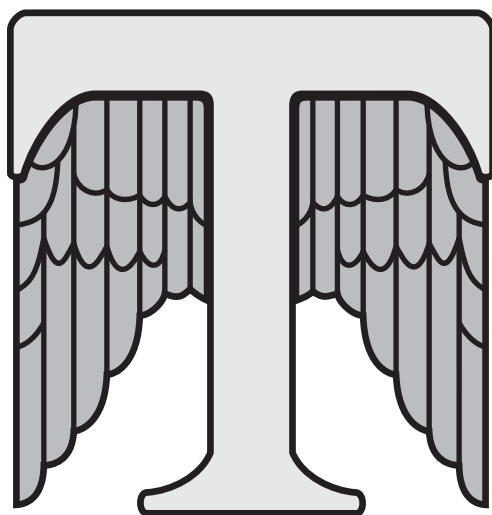

Citadel 1.5

*Owner's Manual*

## PREFACE

### CONGRATULATIONS

You have just acquired one of the most advanced and versatile components for the amplification of audio ever to have been developed.

### IMPORTANT

Save all packaging in a dry place away from fire hazards. Your Citadel 1.5 is a precision electronic instrument and should be properly packaged any time shipment is made. In the unlikely event that you have to return your Citadel 1.5 to the factory or dealer for service or updating, the original packaging will best protect the unit from shipping damage.

In order to achieve the fullest flexibility and enjoyment from your Citadel 1.5, we at Theta recommend that you read this manual in full before connecting the unit to your audio system.

**Note:** It is imperative that the Citadel 1.5 be operated in a well-ventilated environment and that the immediate external temperature be maintained as specified. External cooling fans may be required in some cases. Do not stack any equipment directly above, below or to the immediate sides of the Citadel 1.5 to protect it from overheating, as well as to protect the continued functionality of equipment near and around it.

**Warning:** The Citadel 1.5 is a balanced bridge amplifier, thus the negative speaker terminal is **NOT** a ground, and cannot be connected to a system ground or a loudspeaker system with a common ground. Consult your speaker manufacturer to ensure that any speaker in your system that will be connected to the Citadel 1.5 does **NOT** have internal circuitry with a common ground.

**WARNING:** When connecting the speaker wire to the Delrin output connector, using the hex tool provided – **DO NOT OVER TIGHTEN**. There is a lot of surface area in the Delrin connector to create a complete connection with a minimum of torque applied. **OVER TIGHTENING WILL ULTIMATELY BREAK THE DELRIN CONNECTOR, WHICH WILL NOT BE COVERED UNDER WARRANTY.**

### WARNING

United States law prohibits disposition of these commodities to Libya, Laos, North Korea, Cambodia or Cuba unless otherwise authorized by the United States.

© 2001 Theta Digital Corporation. All rights reserved.  
Written and Illustrated by Glenn Buckley.

This manual is also available for download as a PDF file at Theta Digital's website. <http://www.thetadigital.com>

No part of this publication may be reproduced or transmitted in any form or by any means, electronic or mechanical, for any purpose, without the express written permission of Theta Digital Corporation.

	<b>CAUTION</b> RISK OF ELECTRICAL SHOCK DO NOT OPEN	
CAUTION: TO REDUCE THE RISK OF ELECTRICAL SHOCK, DO NOT REMOVE COVER (OR BACK) NO USER-SERVICEABLE PARTS INSIDE REFER SERVICING TO QUALIFIED SERVICE PERSONNEL		

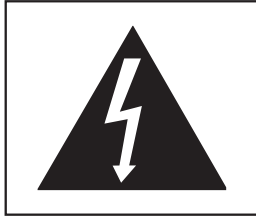

The lightning flash with arrowhead symbol, within an equilateral triangle, is intended to alert the user to the presence of uninsulated “dangerous voltage” within the product’s enclosure that may be of significant magnitude to constitute a risk of electric shock to persons.



The exclamation point within an equilateral triangle is intended to alert the user to the presence of important operating and maintenance (servicing) instructions in the literature accompanying the product.

**WARNING**

**TO REDUCE THE RISK OF FIRE OR ELECTRIC SHOCK,  
DO NOT EXPOSE THIS PRODUCT TO RAIN OR MOISTURE**

---

CAUTION: TO PREVENT ELECTRIC SHOCK, DO NOT USE THE AC (POLARIZED) PLUG WITH AN EXTENSION CORD, RECEPTACLE OR OTHER OUTLET UNLESS THE BLADES CAN BE FULLY INSERTED TO PREVENT BLADE EXPOSURE.

---

Extension cords are not recommended for use with this product.

# Citadel 1.5 Identification Record

This information is for your records and for future identification of the Citadel 1.5. Please take a moment to fill out all pertinent data now, and as upgrades and/or options are installed. **Whenever upgrades, inquiries and/or changes are requested, the serial number will be required.**

SERIAL NUMBER \_\_\_\_\_

DATE PURCHASED \_\_\_\_\_

DEALER'S NAME \_\_\_\_\_

DEALER'S ADDRESS/PHONE \_\_\_\_\_

INSTALLED CARDS/OPTIONS \_\_\_\_\_  
*(Date of installation)*

\_\_\_\_\_  
*(Date of installation)*

\_\_\_\_\_  
*(Date of installation)*

\_\_\_\_\_  
*(Date of installation)*

## **SAFETY PRECAUTIONS**

Please carefully read each item of the operating instructions and safety precautions before installing and using this product. Use extra care to follow the warnings written on the product itself and/or in the operating instructions. Keep the operating instructions and safety precautions for future reference.

**CAUTION: TO REDUCE THE RISK OF ELECTRICAL SHOCK, DO NOT REMOVE ANY OF THE COVER PANELS.**

**NO USER-SERVICEABLE PARTS INSIDE. REFER ALL SERVICING TO QUALIFIED SERVICE PERSONNEL ONLY.**

**TO PREVENT FIRE OR SHOCK HAZARD, DO NOT ALLOW LIQUIDS TO SPILL OR OBJECTS TO FALL INTO ANY OPENINGS OF THE PRODUCT.**

**THIS UNIT IS SUPPLIED WITH TWO 3 PIN GROUNDED AC PLUGS. ALWAYS INSERT THE AC PLUGS INTO GROUNDED OUTLETS. DO NOT REMOVE THE GROUND PINS OR DISABLE THE GROUNDS FOR ANY PURPOSE.**

**BEFORE MAKING ANY CONNECTIONS TO THE CITADEL 1.5, FIRST TURN OFF THE POWER AND THEN DISCONNECT THE AC POWER CORD(S).**

**WHEN INSTALLING THE CITADEL 1.5 IN YOUR SYSTEM, MAKE CERTAIN TO ALLOW A MINIMUM OF 6 INCHES OF VENTILATION ON TOP AND ON EACH SIDE OF THE UNIT. IMPROPER VENTILATION OF THE UNIT MAY CAUSE OVERHEATING, WHICH MAY DAMAGE THE UNIT AND CAUSE A FIRE. PLACE THE UNIT ON A SOLID SURFACE ONLY. I.E. NOT ON CARPET, ETC.**

**DO NOT PLACE THE CITADEL 1.5 NEAR HEAT SOURCES SUCH AS DIRECT SUNLIGHT, STOVES, HEAT REGISTERS, RADIATORS OR OTHER HEAT PRODUCING EQUIPMENT.**

**TO PREVENT DAMAGE TO THE ANALOG OUTPUT CIRCUITRY, BE CERTAIN NOT TO SHORT THE OUTPUT SIGNAL TO GROUND. ENSURE THAT YOUR AUDIO OUTPUT CABLES DO NOT HAVE ANY INTERNAL SHORTS BEFORE CONNECTING THEM TO THE CITADEL 1.5.**

**IF REPLACEMENT OF THE AC LINE FUSE AND/OR ANY INTERNAL FUSE BECOMES NECESSARY, REPLACE ONLY WITH SAME VALUE AND TYPE OF FUSE. NEVER BYPASS THE FUSE.**

**IF THE AC CORD(S) BECOME DAMAGED, DO NOT USE IT/THEM. IMMEDIATELY REPLACE IT/THEM WITH NEW ONES OF THE SAME OR BETTER RATING.**

**IT IS IMPERATIVE THAT THE CITADEL 1.5 BE OPERATED IN A WELL VENTILATED ENVIRONMENT AND THE IMMEDIATE EXTERNAL TEMPERATURE BE MAINTAINED AS SPECIFIED. EXTERNAL COOLING FANS MAY BE REQUIRED IN SOME CASES. DO NOT STACK ANY EQUIPMENT DIRECTLY ABOVE, BELOW OR TO THE IMMEDIATE SIDES OF THE CITADEL 1.5 AS TO PROTECT IT FROM OVERHEATING, AS WELL AS THE CONTINUED FUNCTIONALITY OF ANY EQUIPMENT NEAR AND AROUND IT.**

**THE CITADEL 1.5 IS A BALANCED BRIDGE AMPLIFIER, THUS THE NEGATIVE SPEAKER TERMINAL IS NOT A GROUND, AND CANNOT BE CONNECTED TO A SYSTEM GROUND OR LOUDSPEAKER SYSTEM WITH A COMMON GROUND. CONSULT YOUR SPEAKER MANUFACTURER TO ENSURE THAT ANY SPEAKER IN YOUR SYSTEM THAT WILL BE CONNECTED TO THE CITADEL 1.5 DOES NOT HAVE INTERNAL CIRCUITRY WITH A COMMON GROUND.**

### **AFTER MARKET and THIRD PARTY MODIFICATIONS**

Please note that any after market and/or third party modifications will void the warranty. In the case of changing the feet on a unit, in order to prevent any damage (which will also not be covered under warranty), please verify that the screws being used to secure non-Theta feet do not screw any deeper into the chassis than the original ones. The original screw is 1/4-20 by 1/2 and goes into the chassis 1/8 inch.

## Table of Contents

PREFACE .....	i
<b>WARNING</b> .....	<b>ii</b>
Citadel 1.5 Identification Record .....	iii
<b>SAFETY PRECAUTIONS</b> .....	<b>iv</b>
INTRODUCTION .....	1
Getting to know your Citadel 1.5.....	1
Burn-In Time .....	1
Reference Manual Conventions.....	1
<b>IMPORTANT NOTICE</b> .....	<b>2</b>
Citadel 1.5 Block Diagram.....	3
Front Panel Layout.....	4
Rear Panel Layout .....	6
OPERATION .....	8
Connecting the Citadel 1.5.....	8
Setup and Operation .....	8
Remote Triggers .....	8
RS232 .....	9
Appendix A    Troubleshooting Guide .....	10
Appendix B    Wiring Diagram.....	11
Appendix C    RS232 Protocol .....	13
RS232 Jumper Settings .....	16
Appendix D    Specifications .....	17

# INTRODUCTION

## Getting to know your Citadel 1.5

This Citadel 1.5 has been put through a rigorous and unique testing procedure that ensures that it will last for many years with minimal service requirements. This procedure includes the following:

- All assembled circuit boards are given a thorough visual inspection and are then tested in a bench-reference Citadel 1.5.
- The tested, assembled circuit boards are then installed in a new Citadel 1.5 and the whole unit is tested for every function and parameter.
- The unit is put on a burn-in torture rack to test for any possible component failures.
- It is then tested on an audio analyzer for all pertinent parameters.
- The unit has all remaining chassis components installed and then undergoes a complete visual inspection, which assures that all Citadel 1.5s meet visual specifications.
- The Citadel 1.5 then undergoes a critical listening and functional test.

The front panel of the Citadel 1.5 is manufactured in two versions – a left and a right, as shown in figure 3. A left version has the tower on the right side of the faceplate and is intended to be placed on the left side of the room. Visa versa for the right.

## Burn-In Time

This unit has a break in period of about 1 week during which continuous improvement in sound quality will be observed. It is recommended that music be played continuously through the unit during this time to expedite the break in period.

## Reference Manual Conventions

For clarity purposes, references to buttons and LED's will be shown in bold capital letters.

## IMPORTANT NOTICE

- I. It is imperative that the Citadel 1.5 be connected to a ground via its two three wire AC power cords. It is important that the AC power outlet, which the Citadel 1.5 is plugged into, is actually grounded. Failure to do so will severely compromise the performance, reliability and safety of use of the Citadel 1.5.
- II. Ventilation is an important issue when placing the Citadel 1.5 in a system. Make certain that the Citadel 1.5 is placed in a well-ventilated area or rack unit. Heat must be dissipated and cool air must be allowed to enter the Citadel 1.5.
- III. Please take note that some powerline conditioners defeat the AC power ground on their outlets. If the intention is to plug the Citadel 1.5 into a line conditioner, check with your dealer to make certain that the particular conditioner that is intended for use DOES NOT DEFEAT THE AC GROUND on its AC outlets. Only the highest powered line conditioners should be considered for use with the Citadel 1.5. Otherwise, the amplifier's power output may be compromised.
- IV. DO NOT remove any cover panels from the Citadel 1.5, as there are no user serviceable components inside. Refer servicing and updating to qualified service personnel only.
- V. Endcaps (**NOT** shorting plugs) on the unused RCA inputs will improve the sound quality and may reduce the susceptibility to RF induced anomalies.
- VI. It is imperative that the Citadel 1.5 be operated in a well ventilated environment and the immediate external temperature be maintained as specified in Appendix D of this manual. External cooling fans may be required in some cases. Do not stack any equipment directly above, below or to the sides of the Citadel 1.5 as to protect it from overheating, as well as the continued functionality of any equipment near and around it.
- VII. Each channel is a balanced bridge amplifier, thus the negative speaker terminal is **NOT** a ground, and cannot be connected to a ground or a loudspeaker system with a common ground. Consult your speaker manufacturer to ensure that any speaker in your system that will be connected to the Citadel 1.5 does **NOT** have internal circuitry with a common ground.
- VIII. **WARNING:** When connecting the speaker wire to the Delrin output connector, using the hex tool provided – **DO NOT OVER TIGHTEN**. There is a lot of surface area in the Delrin connector to create a complete connection with a slightly firm torque applied. **OVER TIGHTENING WILL ULTIMATELY BREAK THE DELRIN CONNECTOR, WHICH WILL NOT BE COVERED UNDER WARRANTY.**



# Citadel 1.5 Block Diagram

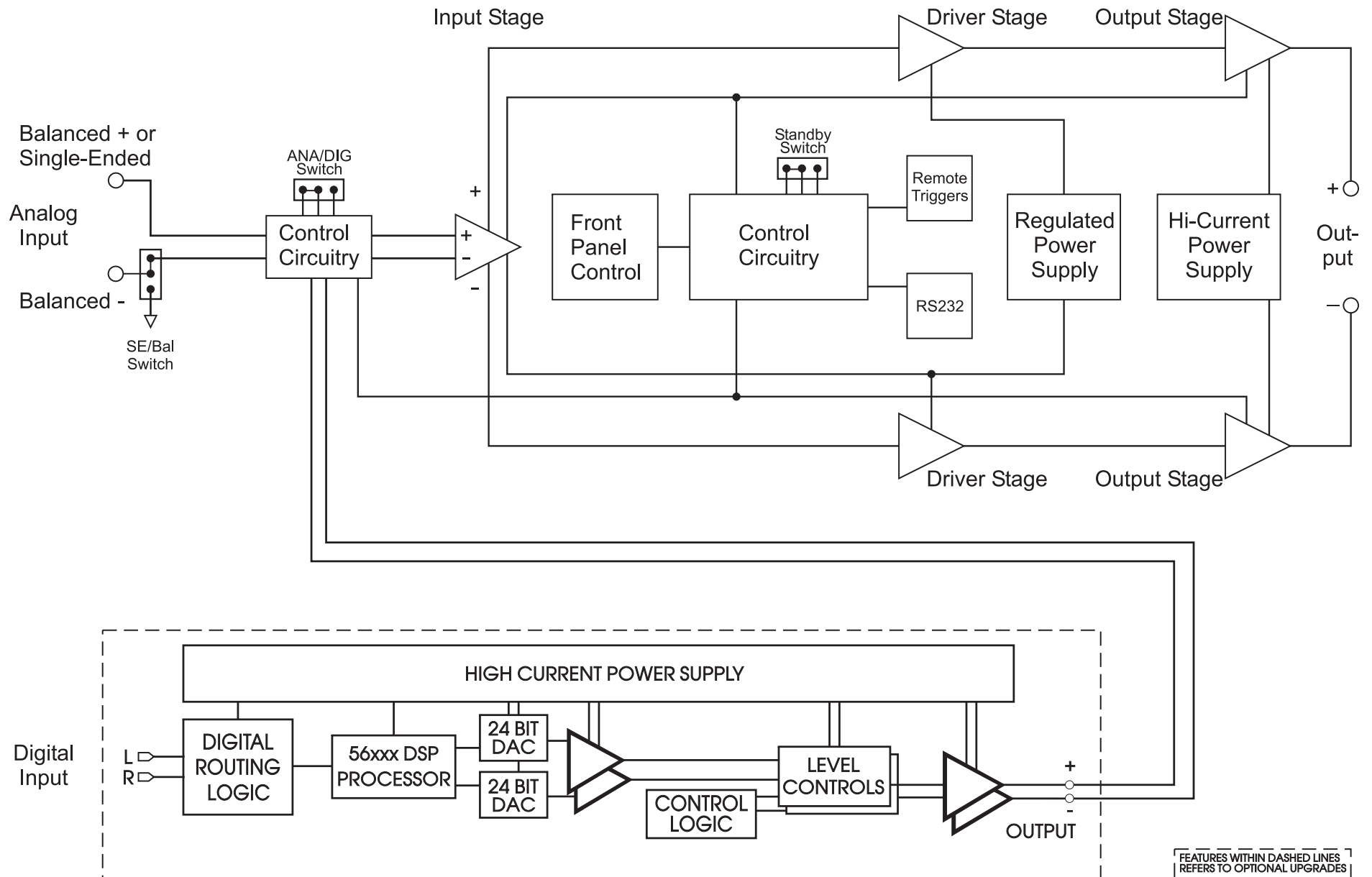
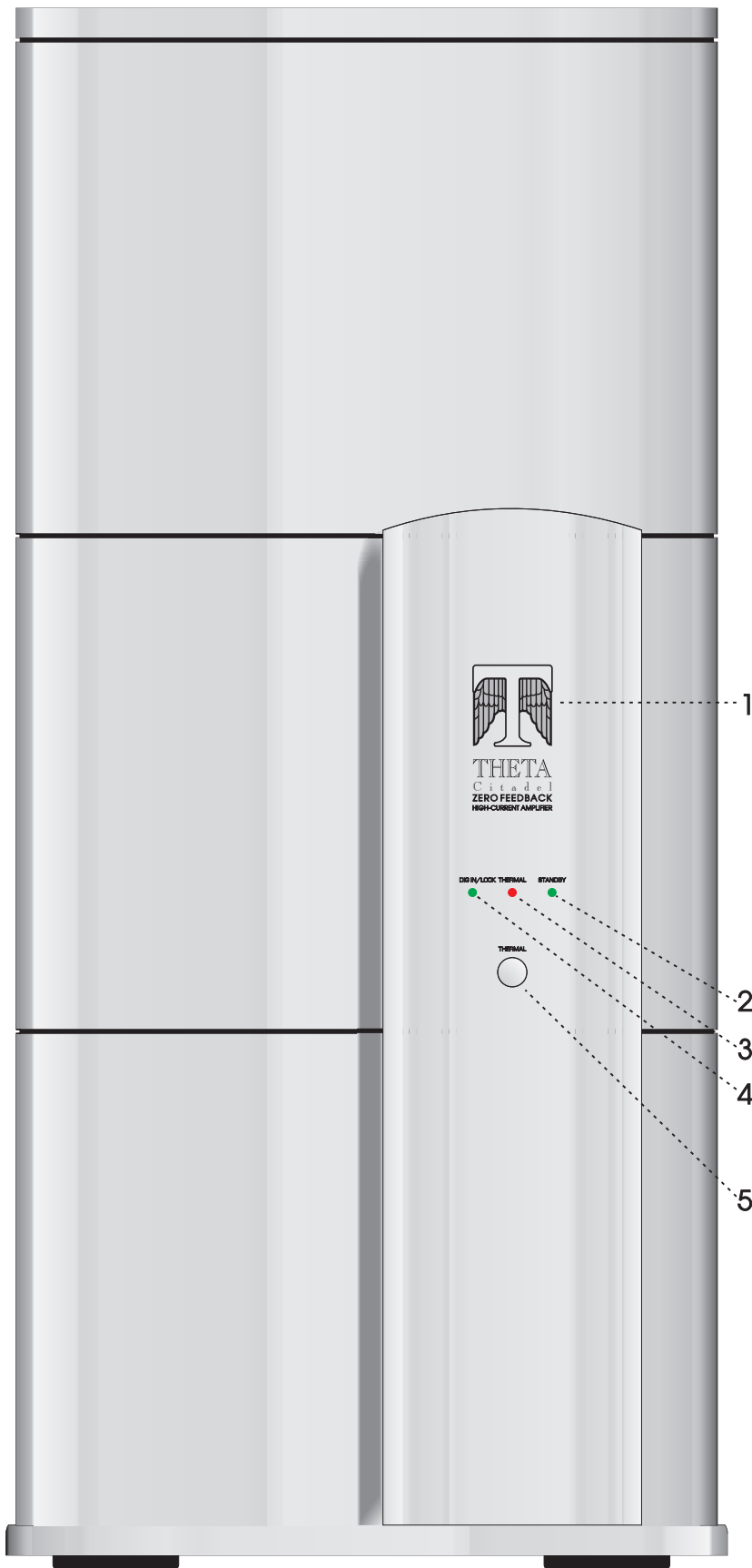

Figure 1 - Block Diagram (Citadel 1.5 showing one output module)

## Front Panel Layout



1. **STANDBY** button. After the rear panel **MAIN POWER** switch is turned on press the front panel Theta logo button to exit the standby mode. The Citadel 1.5 will come out of standby.

2. **STANDBY LED**. Illuminates red when the power amplifier is in **STANDBY**, green when the amplifier is active.

3. **THERMAL LED**. Illuminates when the Citadel 1.5's amplifier module temperature rises above the maximum operating temperature and puts the Citadel 1.5 into standby.

4. **DIG IN/LOCK LED**. When the optional internal DAC is installed, this LED will illuminate red. When a valid digital signal is present at it's input, it will illuminate orange. When Analog is selected, it will illuminate green.

5. **ANA/DIG INPUT** button. Selects between an analog or digital input. This button has no effect if a DAC board is not installed.

Figure 2 - Front Panel Layout of a LEFT Citadel 1.5



**Figure 3 - Front Panel of a LEFT and RIGHT Citadel 1.5**

## Rear Panel Layout

1. **BINDING POST.** Connect plus and minus speaker wires for one speaker to appropriately marked terminals of this post.
2. Optional second **BINDING POST.** This is used when bi-wiring a speaker.
3. RJ45 **RS232** connector. Used for connecting an external controller to the Citadel 1.5 to control and monitor its functions.
4. DB9 **RS232** connector. See RJ45 RS232 connector.
5. **STANDBY REMOTE TRIGGER** jack. When the rear panel **STANDBY TRIGGER** jack receives a 5-12 VDC pulse the Citadel 1.5 will change its mode from either standby to operate, or operate to standby, depending on its current mode.
6. **INPUT SELECT REMOTE TRIGGER** jack. When the rear panel **INPUT SELECT** jack receives a 5-12 VDC pulse the Citadel 1.5 will select either the analog or digital input. This has no effect if the optional DAC board is not installed.
7. **THERMAL LED.** Illuminates when the amplifier rises above the maximum operating temperature. The Citadel 1.5 should be powered off and cooled if this LED is lit.
8. **FUSE RAIL + LED.** When this LED is illuminated, an internal fuse on the positive rail of the channel is blown.
9. **FUSE RAIL - LED.** When this LED is illuminated, an internal fuse on the negative rail of the channel is blown.
10. Optional DAC. (Planned future upgrade).
11. **SINGLE-ENDED** input jack.
12. **BALANCED** input jack.
13. **SINGLE-ENDED/BALANCED** input selector switch. Activates either the single-ended or balanced input jack.
14. **MAIN POWER DIGITAL** switch. This is used only if the optional DAC board is installed.
15. **MAIN POWER ANALOG** switch. Master power switch. Disconnects AC to all circuits except optional DAC. It is recommended that this be left ON at all times during regular use with the exception of whenever cables are connected/disconnected or when the unit is not going to be used for an extended period of time.
16. Main Power Analog **FUSE.** If necessary, replace with same type and rating only.
17. Main Power Digital **FUSE.** If necessary, replace with same type and rating only.
18. Main amplifier **AC POWER INPUT.**

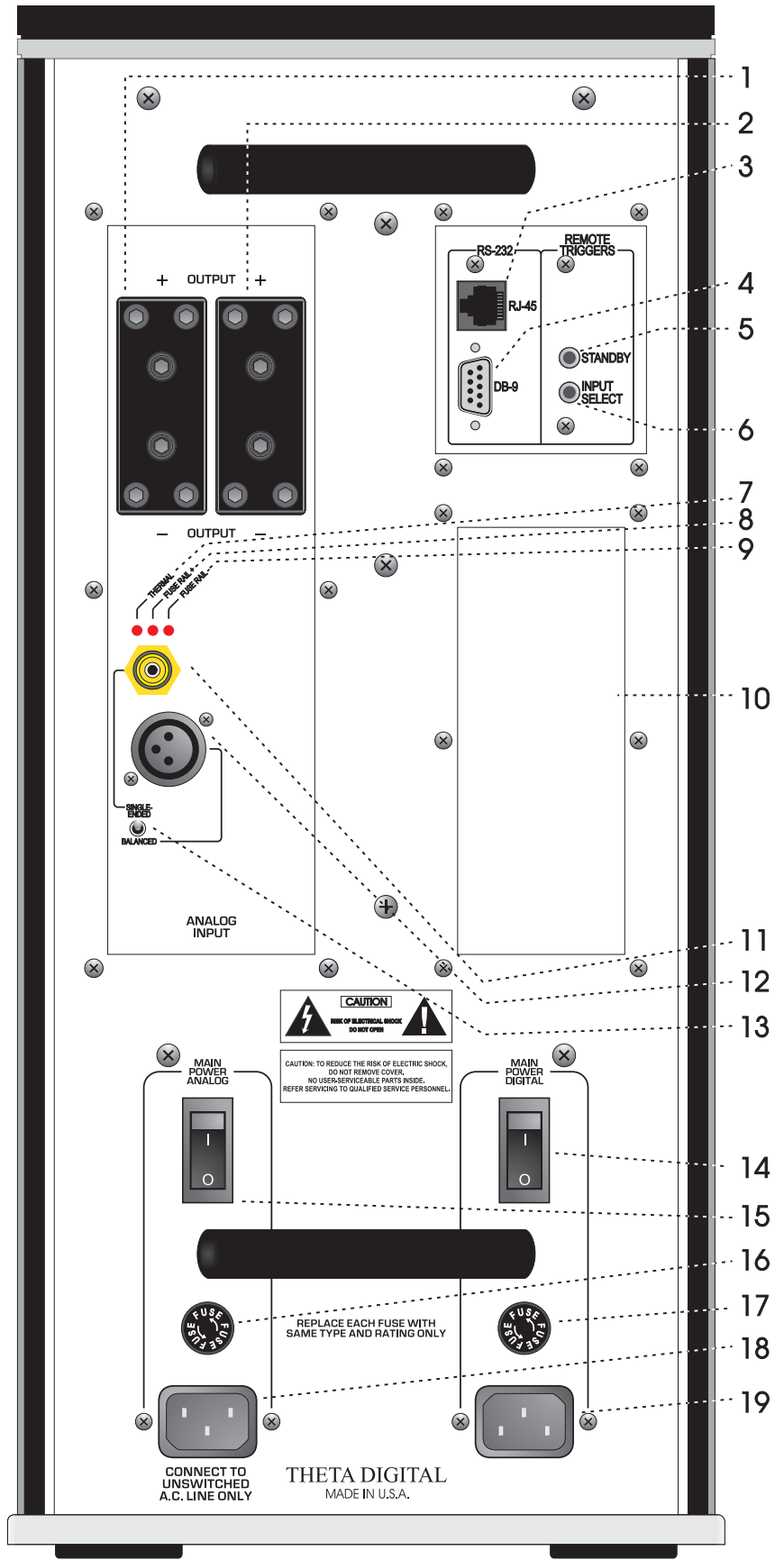

Figure 4 – Rear Panel Layout showing most options installed

19. Digital **AC POWER INPUT.** Used only if the optional DAC board is installed and used.



## OPERATION

Before turning on the Citadel 1.5, ensure that all precautions and warnings have been carefully reviewed and adhered to. Damage to the Citadel 1.5 caused by improper operation, wiring and/or ventilation will not be covered under warranty and Theta will not be liable for any consequential damage or loss.

### Connecting the Citadel 1.5

With both of the Citadel 1.5's rear panel main power switches turned off, connect the signal outputs of the preamp/processor to either the single-ended or balanced input of the Citadel 1.5. Connect the output to the input of the speaker that is intended to be driven. Please refer to figure 5.

Set the rear panel **SINGLE-ENDED/BALANCED** switch to the appropriate position, depending on which analog input is being used.

If the Citadel 1.5 has a second binding post output connector, this is to be connected to the second speaker input terminal.

If the Citadel 1.5 has an optional DAC board installed, connect the digital output of the preamp/processor to the appropriate digital input of the Citadel 1.5.

**Please Note:** The Citadel 1.5 is a balanced bridge amplifier, thus the negative speaker terminal is **NOT** a ground, and cannot be connected to a ground or a loudspeaker system with a common ground. Consult your speaker manufacturer to ensure that any speaker in your system that will be connected to the Citadel 1.5 does **NOT** have internal circuitry with a common ground.

Connect a 12V pulse trigger source to the **STANDBY** trigger input of the Citadel 1.5, if it is desired to be taken in and out of standby via another device.

Connect a 12V pulse trigger source to the **INPUT SELECT** trigger input of the Citadel 1.5 if it is desired to have an external trigger source select between the analog and digital input of the Citadel 1.5.

If the Citadel 1.5's functionality is to be controlled from a remote controller via RS232, connect the RS232 cable between the Citadel 1.5 and the controller, using either the DB9 or RJ45 RS232 connector on the Citadel 1.5.

### Setup and Operation

Turn the output volume of the preamp/processor, or other source device, down all of the way.

Turn on the **MAIN POWER ANALOG** switch, located on the rear panel. If the optional DAC is to be used, also turn on the **MAIN POWER DIGITAL** switch.

When first turning on the rear panel power switch, the red **STANDBY LED** on the front panel will illuminate, indicating that the Citadel 1.5 is in standby mode. When in standby, the signal is muted and the output bias of the Citadel 1.5 is reduced to approximately 10 percent.

Press the metal Theta Digital logo on the front panel to take the Citadel 1.5 out of standby. The **STANDBY LED** will turn from red to green.

By default, the Citadel 1.5 selects the analog input as the current source. If the optional DAC is installed and intended to be used, pressing the front panel **ANA/DIG INPUT** button will select the DAC as the source, or in other words, select the digital input as the source. If the optional DAC board is installed, the **DIG IN/LOCK LED** on the front panel will be illuminated red, whether it is to be used or not. When there is a valid S/PDIF digital signal present at the input of the DAC board, the **DIG IN/LOCK LED** will illuminate green.

Slowly bring the output volume of the preamp/processor up to an audible level.

### Remote Triggers

When the rear panel **STANDBY** trigger jack receives a 5-12 VDC pulse, the Citadel 1.5 will change its state from either standby to operate, or operate to standby, depending on what the current state is.

When the rear panel **INPUT SELECT** trigger jack received a 5-12V pulse, the Citadel 1.5 will change its input source from analog to digital, or digital to analog, depending on that the current selection is.

## **RS232**

RS232 is another option in the Citadel 1.5. It can be installed at any time either at the factory or by an authorized Theta dealer. All functions of the Citadel 1.5 can be controlled and monitored via RS232, using either the RJ45 or DB9 connector. As long as the rear panel **MAIN POWER ANALOG** switch is turned on, the RS232 circuitry is always active, thus allowing the Citadel 1.5 to be taken out of **STANDBY** via RS232.

## Appendix A Troubleshooting Guide

If the Citadel 1.5 should function abnormally during operation, please review the items in the following checklist. Please be sure to thoroughly check all other connected components such as speakers, preamplifiers, as well as cables.

Symptom	Possible Cause(s)	Remedy
No power or front panel lights and no sound.	One or both of the power cables are not inserted 100% into AC input connector.	Ensure that the AC cord(s) are inserted all the way into the Citadel 1.5 and that the wall outlet is active.
	One or both of the rear panel fuses is open.	Replace with same type and rating ONLY.
No audio output.	Circuit breaker is open (AC outlet).	Check the AC outlet circuit breaker and reset, if necessary, or contact your dealer.
	Overheating	If the front and/or rear panel <b>THERMAL</b> LED is illuminated, shut down the Citadel 1.5 until it cools. An external fan may be necessary.
	<b>SINGLE-ENDED/BALANCED</b> switch is in the incorrect position.	Toggle this switch to select the type of analog input jack currently being used.
	DAC is being used and the lock light is not green.	Press the ANA/DIG INPUT button to select the digital input.
		Verify that the digital cable is fully connected at both ends.
		Ensure that the preamp/processor is outputting a valid S/PDIF signal and that the appropriate channels are turned on.
	Plus or minus fuse is open.	Check the rear panel fuse indicator LEDs. If one is on, an internal fuse is open.
Hot/Warm	Normal operation	



## Appendix B Wiring Diagram

This section provides an example illustration of an input and output wiring scheme. Before making any connections, please turn off ALL audio and video devices. Unplug those that do not have a main power switch. It is recommended that all cables, including speaker cables be kept as short as possible for best sound quality.

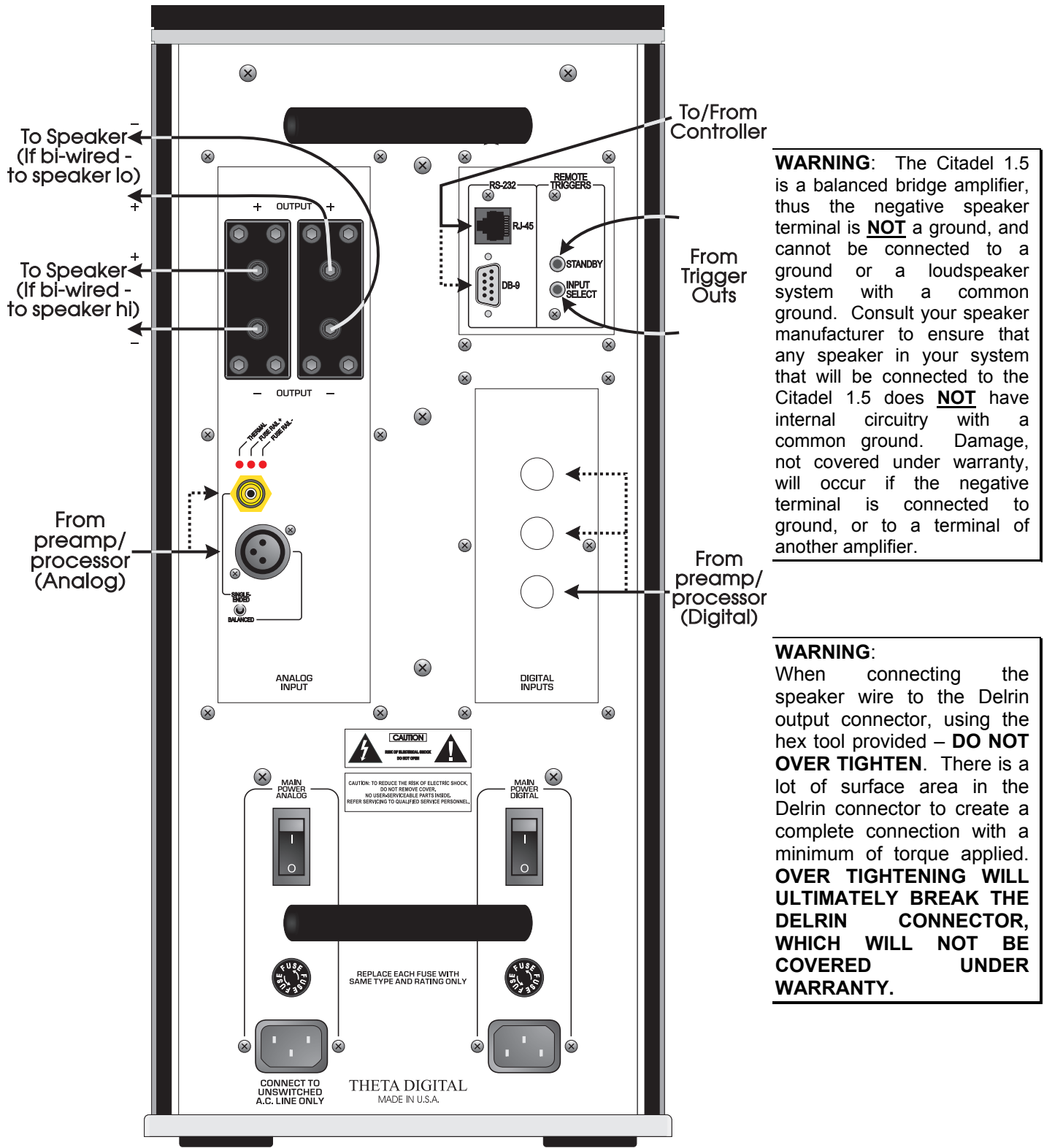

**WARNING:** The Citadel 1.5 is a balanced bridge amplifier, thus the negative speaker terminal is **NOT** a ground, and cannot be connected to a ground or a loudspeaker system with a common ground. Consult your speaker manufacturer to ensure that any speaker in your system that will be connected to the Citadel 1.5 does **NOT** have internal circuitry with a common ground. Damage, not covered under warranty, will occur if the negative terminal is connected to ground, or to a terminal of another amplifier.

**WARNING:** When connecting the speaker wire to the Delrin output connector, using the hex tool provided – **DO NOT OVER TIGHTEN**. There is a lot of surface area in the Delrin connector to create a complete connection with a minimum of torque applied. **OVER TIGHTENING WILL ULTIMATELY BREAK THE DELRIN CONNECTOR, WHICH WILL NOT BE COVERED UNDER WARRANTY.**

Figure 5 - Examples of Typical Input and Output Connections

----- = optional connection.



## Appendix C RS232 Protocol

RS232 settings are internally definable via jumper blocks, to accommodate interfacing with a wide range of control products.

Baud rate	9600 or 19200
Echo status	AUTO or REQUEST
Select C	0 or 1
Select D	0 or 1
Select E	0 or 1

Baud rate: Maximum number of bits per second. The duration of a single bit is equal to 1 / baud rate.

Echo status: Specifies whether the **STATUS** of each parameter shown in the protocol will automatically (**AUTO**) be echoed back to the controller when there is any change, or whether the user must manually request (**REQ**) the status information be sent to the controller.

Select C,D & E The three **SELECT** jumpers are used to set the unit ID. There are a possible 8 configurations.

All commands will follow the format:

<Header><Command Identifier><Argument 1><Argument 2><Argument 3>

where:

<Header> = <FEh><E0h> \*\*

<Command identifier> = <byte>

<Argument x> = <byte>

Each command will be able to access the system configuration directly, eliminating the need to press any button on the Citadel 1.5's front panel.

### Examples:

- 1) To put the Citadel 1.5 into standby: Send FE, E0h \*\*, 01, 00, 00, 00 (all values in Hex).  
Where FE and E0h \*\* are the header, 01 = standby command, 00 = put into standby, 00 = filler and 00 = filler (4 characters required).
- 2) To select the source as the optional DAC: Send FE, E0h \*\*, 03, 01, 00, 00  
Where FE and E0h \*\* are the header, 01 = input select command, 01 = digital, 00 = filler and 00 = filler (4 characters required).

\*\* In the examples above, the header ID is set to the Left Citadel 1.5. Replace this data to match the ID of the Citadel 1.5 to be controlled, if different.

Command	Description	Argument 1	Argument 1 Description	Argument 2	Argument 2 Desc	Argument 3	Argument 3 Desc
1	Standby	0	Put in standby				
		1	Take out of standby				
2	Status	0	Return amplifier status.				
3	Input Select	0	Analog				
		1	Digital				
4	Toggle Standby	0	Toggles Amp in/out of standby.				
The RS232 can be set using a hardware jumper to automatically send changes to the RS232 port.							
There can be multiple Citadel 1.5's in a system. Each can have a different device address, selectable on the RS232 board and defined in Status byte #2, below.							
Status Byte #	Byte Desc	Bit	Value Description	Comment			
1	Status	0	Standby	0 = In, 1 = Out			
		1	Temperature	0 = OK, 1 = Over temperature			
		2	Fuse +	0 = Good, 1 = Blown			
		3	Fuse -	1 = Good, 1 = Blown			
		4	DAC Installed	0 = Not Installed, 1 = Installed			
		5	Ana/Dig	0 = Analog, 1 = Digital attempted, regardless of whether DAC installed.			
		6	Signal Path status	0 = Analog, 1 = Digital			
		7	Lock	DAC installed, digital selected, valid digital signal present.			
2	Device Address	Lower 3 bits	0=Front Left, 1=Front right, 2=Amp #3, 3=Amp #4, 4=Amp #5, 5=Amp #6, 6=Amp #7, 7=Amp # 8				

# RS232 Hardware Connections

RTS and CTS are not implemented in the Citadel

## DB9

Pin	I/O	
1 - DCD	0	
2 - Citadel sends on this pin	0	
3 - Citadel receives on this pin	1	
4 - DTR	1	
5 - GND		
6 - DSR	0	
7 - RTS	1	
8 - CTS	0	
9 - Ring	---	

CN2

## RJ45

Pin	I/O	
1 - RTS	1	
2 - DTR	1	
3 - Citadel receives on this pin	1	
4 - GND		
5 - GND		
6 - Citadel sends on this pin	0	
7 - DCD	0	
8 - CTS	0	

CN3

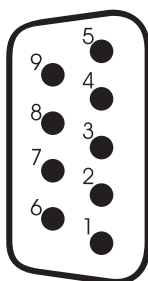

Rear panel view of DB9 connector  
(From outside of unit).

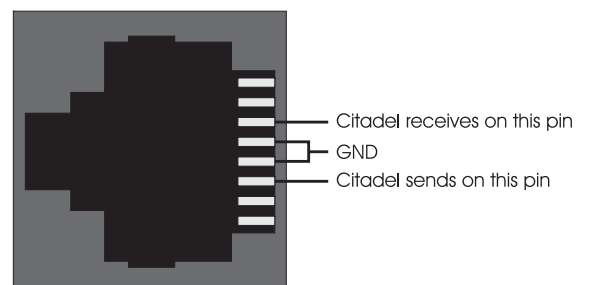

**Note:** The connections shown on this page are internal to the Citadel.  
The RS232 cable should be wired straight pin for pin.

**Figure 6 – Citadel 1.5 RS232 Jack Pinout**

## RS232 Jumper Settings

**Note:** Changing the RS232 jumper settings must be done by an authorized Theta Dealer or Installer ONLY. Removing the cover of the amplifier in all other cases will void the warranty and can cause an electric shock. Please see warnings on page ii.

There are 2 possible Baud rates: **9600** and **19200**. The factory default is **19200**. To change the baud rate to **9600**, move the **BAUD** jumper to the center and top pins (if the RS232 board is orientated as in figure 6). This is also known as position 0.

The **STATUS** can be returned to the controller either automatically every time a parameter has changed, or only on user request. The factory default is **AUTO**. To set the Echo **STATUS** to return Status information only upon request, move the **STATUS** jumper to the top pins position 0), or nearer to **REQ** on the RS232 board.

The three **SELECT** jumpers are used to derive the product ID number, or the “header” ID. The Citadel 1.5 can have any one of up to eight different product ID’s. In this way, when communicating with a Citadel 1.5 via RS232 in a system that has multiple Citadel 1.5s, each one can be controlled separately. When a LEFT Citadel 1.5 is shipped from the factory, it is set to be the Front Left. Accordingly a RIGHT Citadel 1.5 is set to be Front RIGHT.

Address(h)	Address(d)	Jumper EDC	Assignment
FE, E0	254, 224	000	Front Left
FE, E1	254, 225	001	Front Right
FE, E2	254, 226	010	Amp # 3
FE, E3	254, 227	011	Amp # 4
FE, E4	254, 228	100	Amp # 5
FE, E5	254, 229	101	Amp # 6
FE, E6	254, 230	110	Amp # 7
FE, E7	254, 231	111	Amp # 8

Example of changing the Citadel 1.5 header ID to be Amp #3:

Set the jumper on SELECT E to 0, the jumper on SELECT D to 1 and the jumper on SELECT C to 0. The diagram to the right shows the ID set to 001.

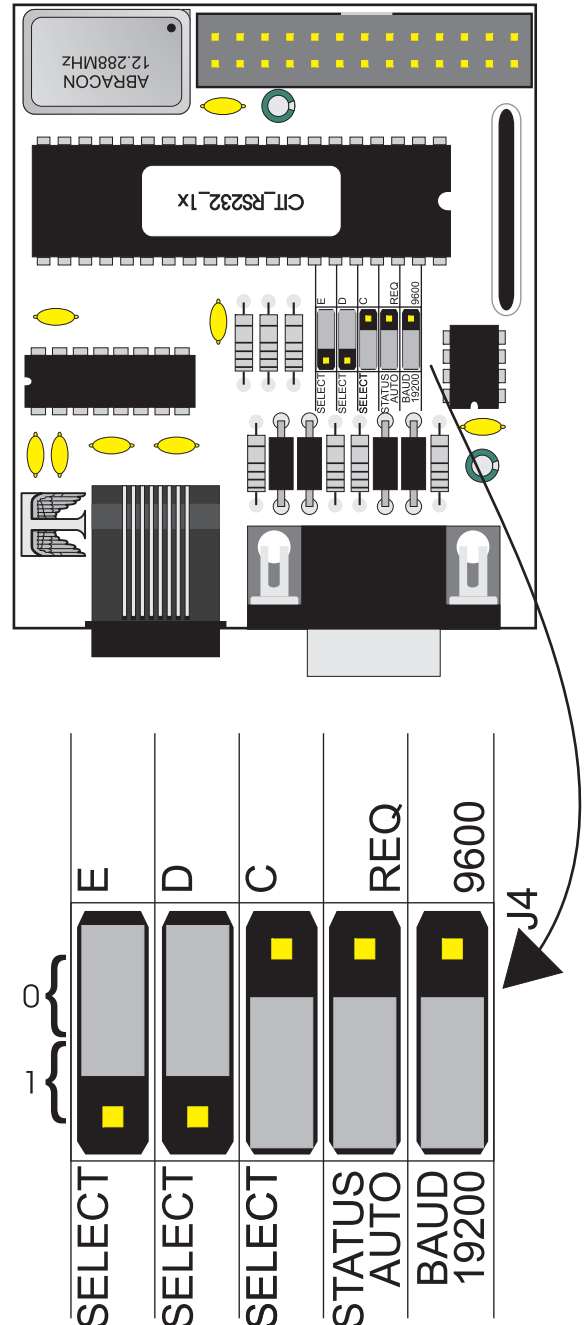

Figure 7 – Citadel 1.5 RS232 Jumper Settings

## Appendix D Specifications

### Inputs:

#### Analog audio:

1 Single-ended RCA jack.  
1 Balanced (XLR) jack.

Input Impedance: 60 K $\Omega$  Single-Ended or Balanced, for each phase.

Input sensitivity: (Single-Ended) 3.1V RMS input for 400W into 8 ohms.  
(Balanced) 1.55V RMS input for 400W into 8 ohms.

Gain: (Single-Ended) 25dB (18x).  
(Balanced) 31dB (36x).

Polarity: (Single-Ended) Non-Inverting.  
(Balanced) Pin-2 = Positive, Pin-3 = Negative for Non-Inverting Output.

#### Digital Audio:

TBA

### Outputs:

Analog Audio: 1 balanced output (Standard); optional second balanced output for bi-wiring.

### I/O

RS232: 1 DB9 and 1 RJ45 connector.

### Modes/Processes:

Standby: Amplifier is muted and output bias is reduced to 20%.

Thermal: Channel has overheated; amp automatically switches to Standby.

### Power Output:

(8 ohms)	400 W (rated)	425 W (typical)
(4 ohms)	600 W (rated)	650 W (typical)
(2 ohms)	800 W (rated)	800 W (typical)

**Frequency Response:** (-3dB points @ full power) 0.2 Hz - 400 KHz.

**THD+Noise:** <2%

**Signal to Noise Ratio:** (unweighted) >103dB

**Power Requirements:** 117 VAC, 15A Slo Blo fuse for analog, 1A Slo blo fuse for digital; 230 VAC, 10A Slo Blo fuse for analog, 1A Slo Blo fuse for digital; 50-60 Hz.

**Power Consumption:** 80W @ Standby; 120W @ idle; 800W @ full power into 8 ohms; 1350W @ 4 ohms, 2100W @ 2 ohms.

**Standby Trigger Input:** 5-12 VDC Pulse between 1 and 500mS.

**Dimensions:** 8 13/16" W x 19 5/8" H x 23 5/8" D (224 x 499 x 600 mm)

**Weight:** 110 Lbs. Stand alone (41.05 Kg), 130 Lbs. Boxed with accessories (48.52 Kg)

**Maximum Operating Temperature:** Internal: 176° F (80° C)  
Room: 131° F (55° C)

90 DAY LIMITED WARRANTY TERMS AND CONDITIONS  
(5 Year optional extended service contract)

1. Theta Digital Corporation, henceforth referred to as Theta, warrants the product designated herein to be free of manufacturing defects in material and workmanship, subject to the conditions set forth herein, for a period of 90 days from the date of purchase by the original purchaser, henceforth referred to as purchaser. If the purchaser registers the unit with Theta by mailing in the warranty card, together with a copy of the bill of sale, within 14 days of the date of purchase, said purchaser will be registered for an extended service contract. The extended service contract extends the 90 days to a period of 5 years from the date of purchase by the original purchaser or no later than 7 years from the date of shipment to the authorized Theta dealer, whichever comes first.

2. **CONDITIONS**

This warranty is subject to the following conditions and limitations. The warranty is void and inapplicable if the product has been used or handled other than in accordance with the instructions in the owner's manual, abused or misused, damaged by accident or neglect or in being transported, or if the defect is due to the product being repaired or tampered with or modified by anyone other than Theta or an authorized Theta repair center. In the unlikely event that the unit requires service, contact Theta for an RA (Return Authorization) number. The product must be packed and returned to Theta or an authorized Theta repair center by the customer at his or her sole expense. Theta will pay return freight of its choice. A returned product must be accompanied by a written description of the defect, a photocopy of the original purchase receipt, and a daytime phone number where the owner can be reached. The unaltered receipt must clearly list model and serial number, the date of purchase, the name and address of the purchaser and authorized dealer and the purchase price. Theta reserves the right to modify the design of any product without obligation to purchasers of previously manufactured products and to change the prices or specifications of any product without notice or obligation to any person.

3. **REMEDY**

In the event the above product fails to meet the warranty, and the above conditions have been met, the purchaser's sole remedy under the limited warranty shall be to obtain an RA number and return the product to Theta or an authorized Theta repair center where the defect will be rectified without charge for parts or labor.

4. **LIMITED TO ORIGINAL PURCHASER**

This warranty is for the sole benefit of the original purchaser of the covered product and shall not be transferred to a subsequent purchaser of the product.

5. **DURATION OF WARRANTY**

This warranty expires 90 days after the date of original purchase. If Theta receives the completed warranty registration card within 14 days of original purchase, this period is extended to the third anniversary of the original date of purchase or no later than the seventh anniversary of the shipment to the authorized Theta dealer, whichever comes first.

6. **MISCELLANEOUS**

**ANY IMPLIED WARRANTIES RELATING TO THE ABOVE PRODUCT SHALL BE LIMITED TO THE DURATION OF THIS WARRANTY. THE WARRANTY DOES NOT EXTEND TO ANY INCIDENTAL OR CONSEQUENTIAL COSTS OR DAMAGES TO THE PURCHASER.** Some states do not allow limitations on how long an implied warranty lasts or an exclusion or limitation of incidental or consequential damages, so the above limitations or exclusions may not apply to you. This warranty gives you specific legal rights, and you may also have other rights which vary from state to state.

7. **WARRANTOR**

Inquiries regarding the above limited warranty may be sent to the following address:

THETA DIGITAL, a division of Amplifier Technologies, Inc.  
1749 Chapin Road  
Montebello, CA 90640

**WARRANTY OUTSIDE THE USA**

Theta has formal distribution in many of the countries of the free world, in each country the Theta Importer has contractually accepted the responsibility for product warranty. Warranty service should normally be obtained from the importing dealer or distributor from whom you obtained your product.

**WARNINGS**

1. To prevent fire or shock hazard, do not expose your Theta product to rain or moisture.
2. This unit contains voltages which can cause serious injury or death. Do not operate with covers removed. Refer all servicing to your authorized Theta dealer.
3. For continued protection against fire hazard, replace fuses only with the same type and rating of fuses as specified.