

Absolute True Fidelity DAC

# RD160





# RD160, Absolute True Fidelity DAC

The RD160 takes every single detail of sound to a new level.

The precise design and innovative technologies of HiFi ROSE, all concentrated on our product RD160, will guide you into a world of purer and more genuine sound. The RD160 offers a digital processing core module that precisely processes digital signals, an architecture to separate digital and analog signals and convert them transparently and precisely without distortion, a fully balanced design to maintain the highest signal purity, three power supply units to independently supply power to each circuit for clearer and more dynamic sound, and even a noise filter to vividly convey the finest details of the sound.

01

Design

02

Technology

03

Feature

04

Appearance

05

Specification

06

Connectivity





01

# Design

# Concept



## 1 Exterior

- Exterior design that combines the aesthetics and intuitiveness of cutting-edge technologies

## 2 Design

- ROSE DPC™ (digital processing core) module
  - Minimizes jitter by accurately synchronizing to a precise clock
- ROSE CIM™ (completely isolated module) architecture
  - DAC module with complete separation of digital and analog
  - DAC module and analog output section designed to be fully balanced
- Three Custom-Designed Reference Linear Power Supplies
- ROSE NRA™ (noise reduction analog) filter
  - Implements flat frequency even in very low frequency bands
- High-precision OCXO clock

## 3 Feature

- Pre-out level setting
- Upsampling & Filters
- Supports optical USB
- Supports external master clock input

## The Fusion of Aesthetics and Intuitiveness of Cutting-Edge Technologies

The RD160 has an appearance that perfectly combines cutting-edge technology and aesthetics. The sophisticated metallic case is luxurious and durable, and the precisely machined edges and smooth surfaces intuitively show the high quality of the product. The hidden screen, elegantly integrated into the front panel, intuitively visualizes the processing and status of digital signals through various display modes, providing a user experience that feels like handling a futuristic device. The elaborately designed knobs and buttons interact with the hidden screen in real time, providing users with an intuitive and satisfying operating experience. More than just a piece of audio equipment, the RD160 is the perfect choice to add modern ambience and technological elegance to your space.





## 02 Technology

## **ROSE DPC(Digital Processing Core)<sup>™</sup> Module**

**The digital stage of the RD160 features the ROSE DPC<sup>™</sup> module, which is designed to ensure that all processing blocks maintain the highest level of signal accuracy and precision to implement precise sound. This module precisely synchronizes digital signals input in various ways to the high-precision OCXO clock and aligns them to I2S signals. It applies clock synchronization and locking processes to minimize jitter, especially when processing high-resolution audio signals, providing accurate signal processing and natural and clear sound. The circuits for user interface and GUI configuration, as well as the path of digital audio signals, are also completely separated to thoroughly block signal distortion and interference. This design ensures that the RD160 delivers high-fidelity audio with maximized digital signal quality and compatibility with a wide range of digital formats.**



# ROSE DPC™ Module

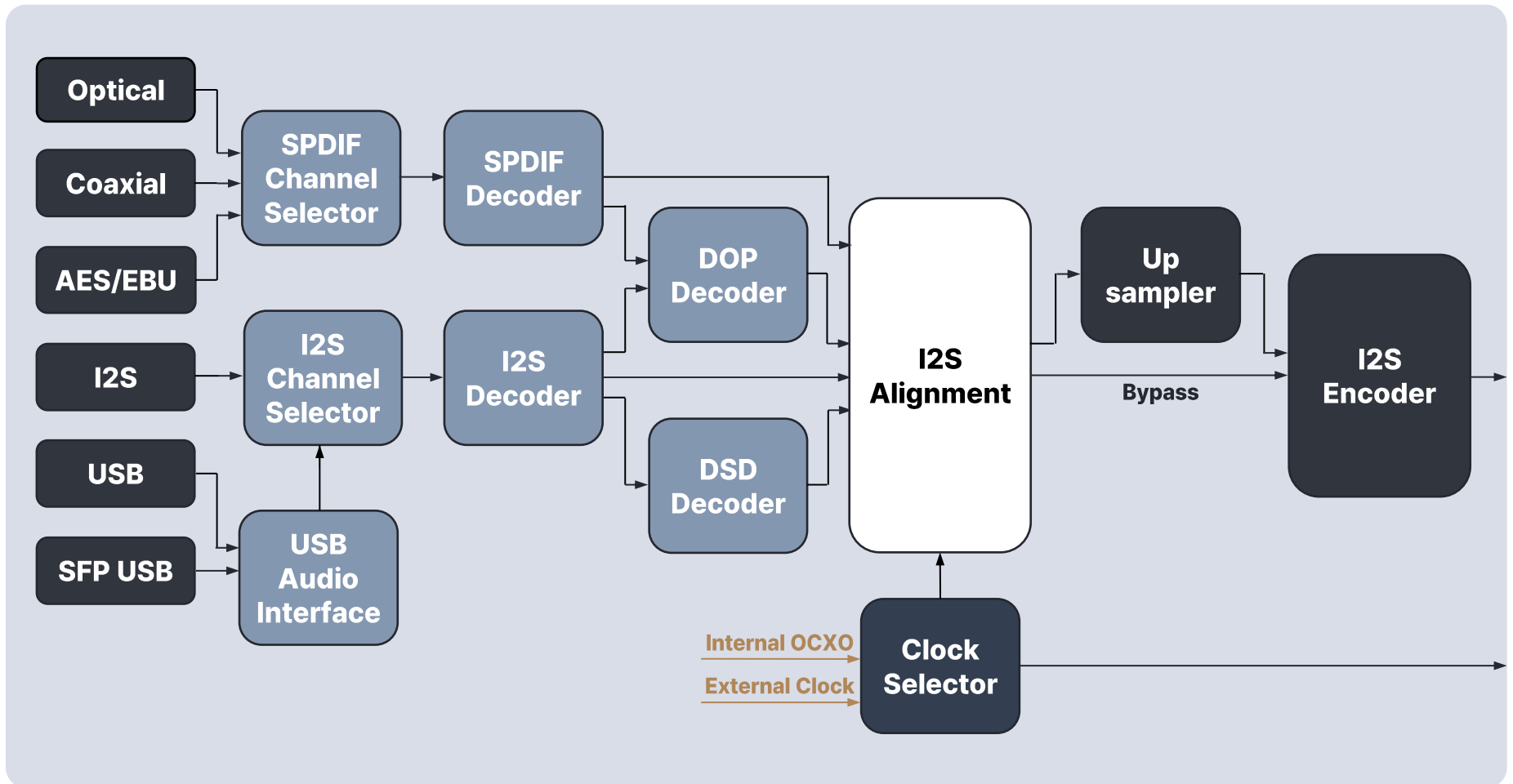

# ROSE CIM™ Architecture

A DAC module with complete separation of digital and analog

The ROSE CIM™ architecture aims to maximize sound quality through complete isolation and modularity. The RD160's DAC module is a two-chip solution, with the AK4191 handling digital filtering and initial delta-sigma modulation stages, while the AK4499EX performs digital-to-analog conversion. By completely separating the digital and analog circuits with this architecture, the RD160 completely blocks noise generated during mutual processing, achieving an extremely high signal-to-noise ratio (SNR) and top-notch analog characteristics.

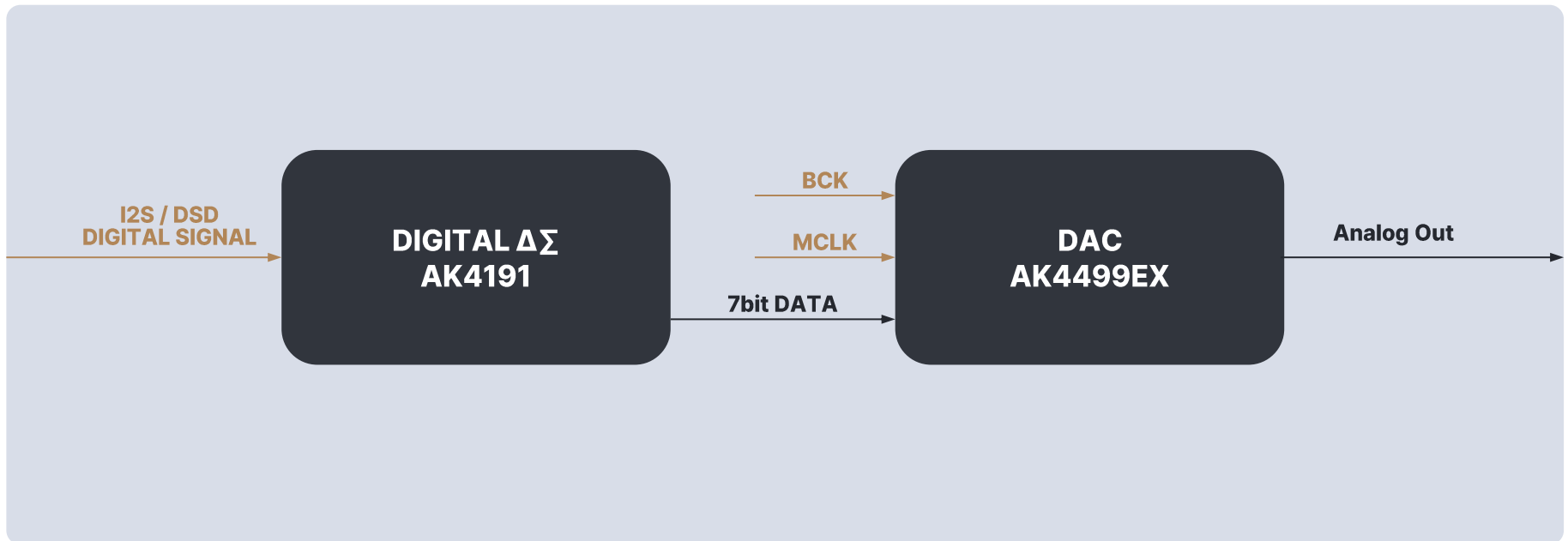

# ROSE CIM™ Architecture

A DAC module and analog output section designed to be fully balanced

Going further, by individually assigning a DAC module to each channel and designing the analog output circuit to be fully balanced and symmetrical, noise that may be generated between channels is fundamentally blocked. This architecture allows the RD160 to achieve outstanding dynamic range, clearly and precisely reproducing even the finest details of the original sound with crisp stereo imaging.

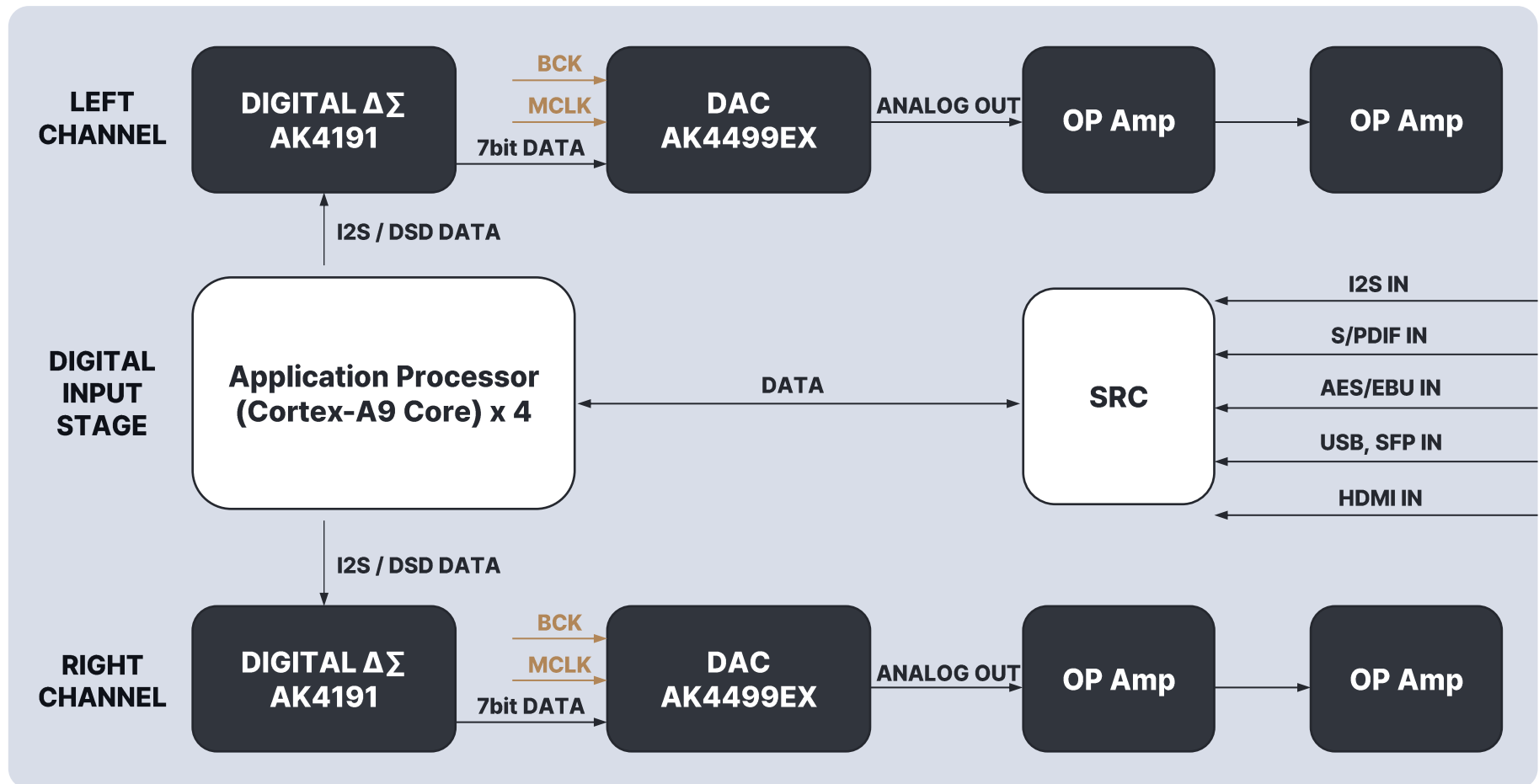

## Three Custom-Designed Reference Linear Power Supplies

Independently developed by HiFi ROSE, the RD160 reference linear power supply is designed to achieve the best sound quality. Based on an ultra-low noise power chipset, the power supply is designed to independently supply power to the digital input ports and the left and right analog output ports. This power supply effectively suppresses noise that may occur in each circuit, such as digital processing, clock, and analog output, by minimizing mutual interference and crosstalk between stages. By stably supplying power according to the power requirements of each stage, it maintains the integrity of the signals, increases the dynamic range and resolution of the DAC, and vividly conveys even the finest details of the audio. It also reduces jitter and maximizes the spatial characteristics of the sound field, providing a wider and more accurate sound stage and clearer images. The RD160's power supply is designed to deliver clearer and more dynamic sound, providing a more immersive listening experience.

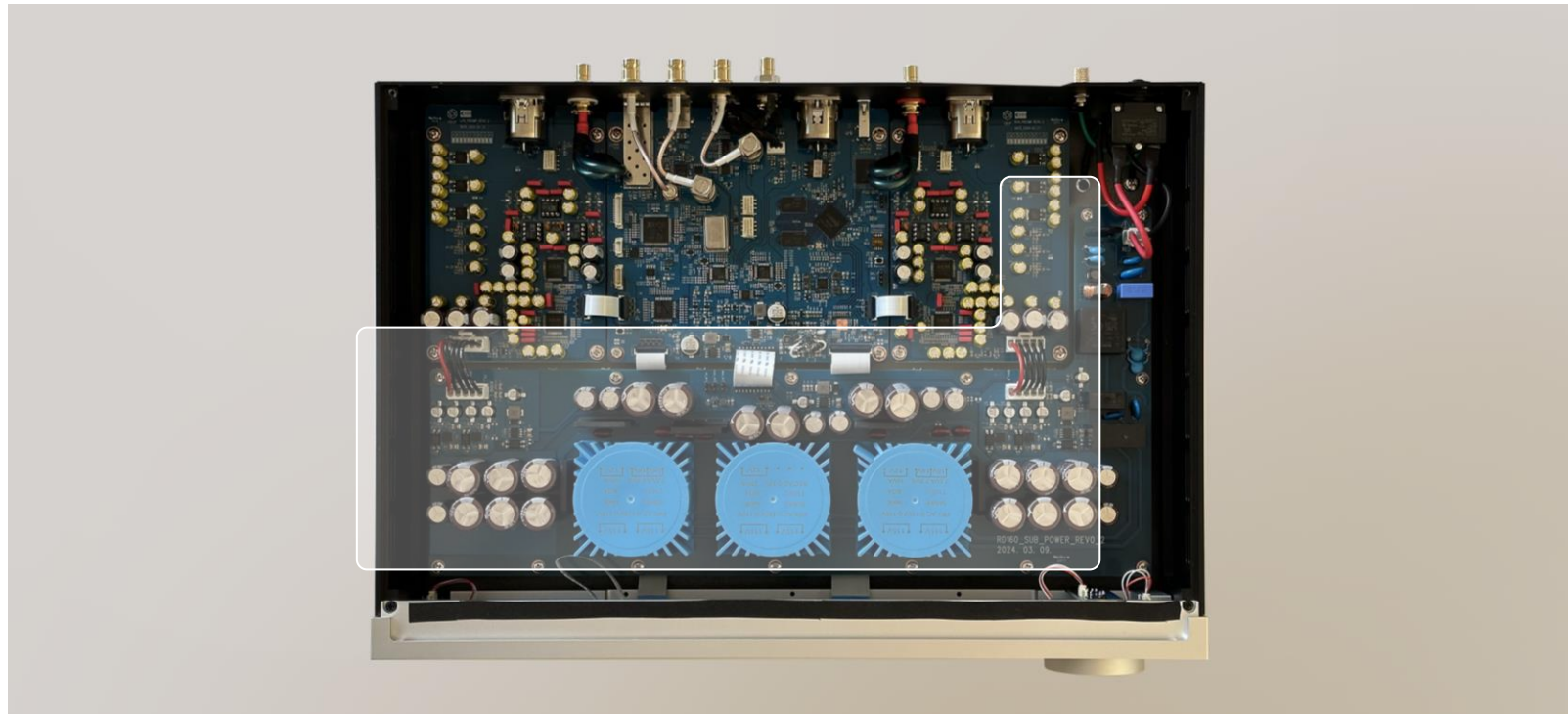

# High Quality J-FET Input Dual OP-Amp

The RD160 features a high-quality J-FET input dual op-amp with excellent response speed, dynamic range, and low total harmonic distortion, using a high-purity oxygen-free copper (OFC) lead frame. The OP-amp of the RD160 was selected through a rigorous and meticulous process to realize natural and vivid sound and bring out the best performance.

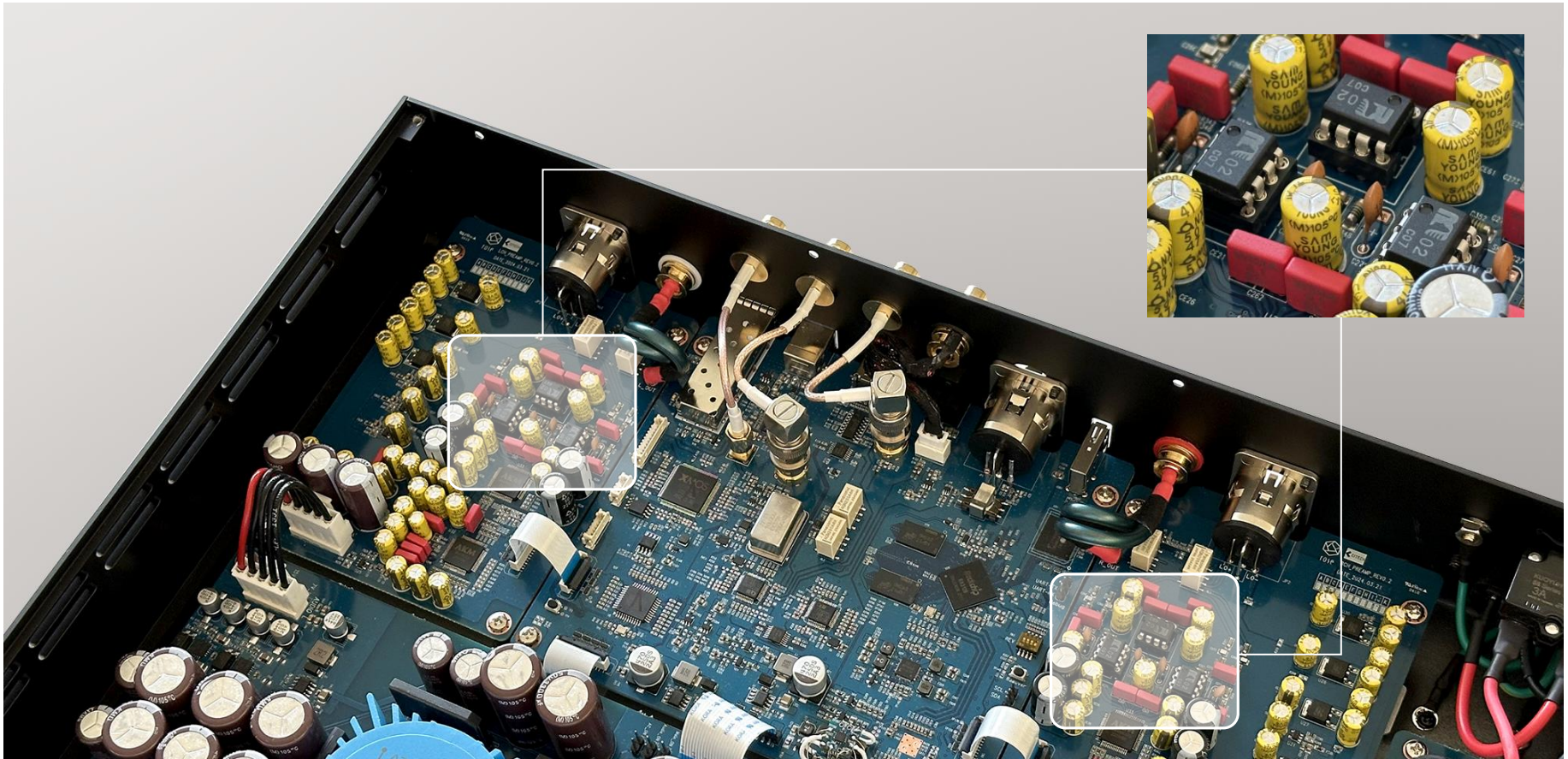

# ROSE NRA(Noise Reduction Analog)™ Filter

The analog stage with ROSE NRA™ filter achieves flat frequency response even in very low frequency bands. This leads to the RD160 having a wide, fixed frequency response without roll-off across the entire bandwidth, and clearly and faithfully conveying the original sound information contained in high-resolution audio, from the deep, heavy ultra-low range that you can feel on your skin to the ultra-high range that conveys the ambiance of the recording site.

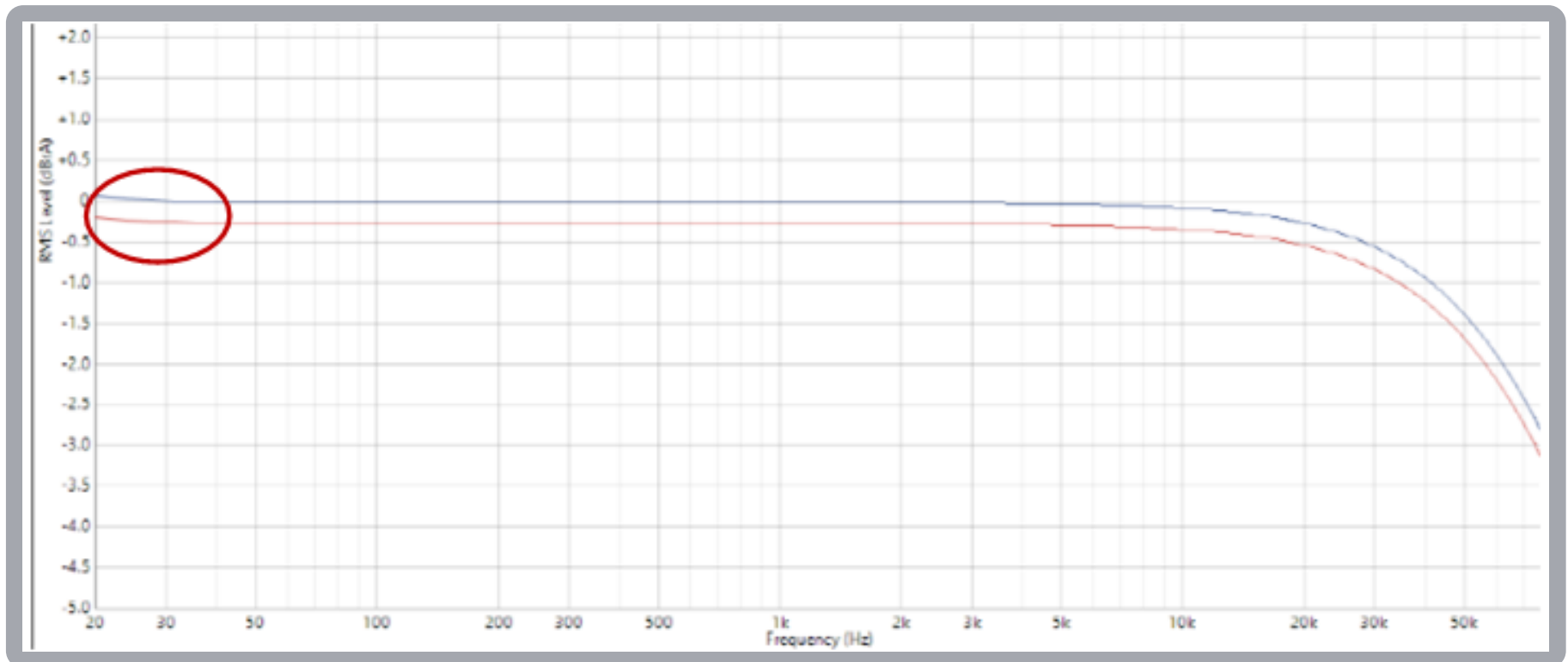

# An Interior Made with the Finest Materials

High-purity oxygen-free copper (OFC) cables are used where critical for superb sound quality, including the power and audio input/output ports. The analog unbalanced output ports are made of high-purity single-crystal OCC that is processed through the Ohno continuous casting process (OCC) to ensure excellent conductivity so that the signal is transmitted with high purity and without distortion.

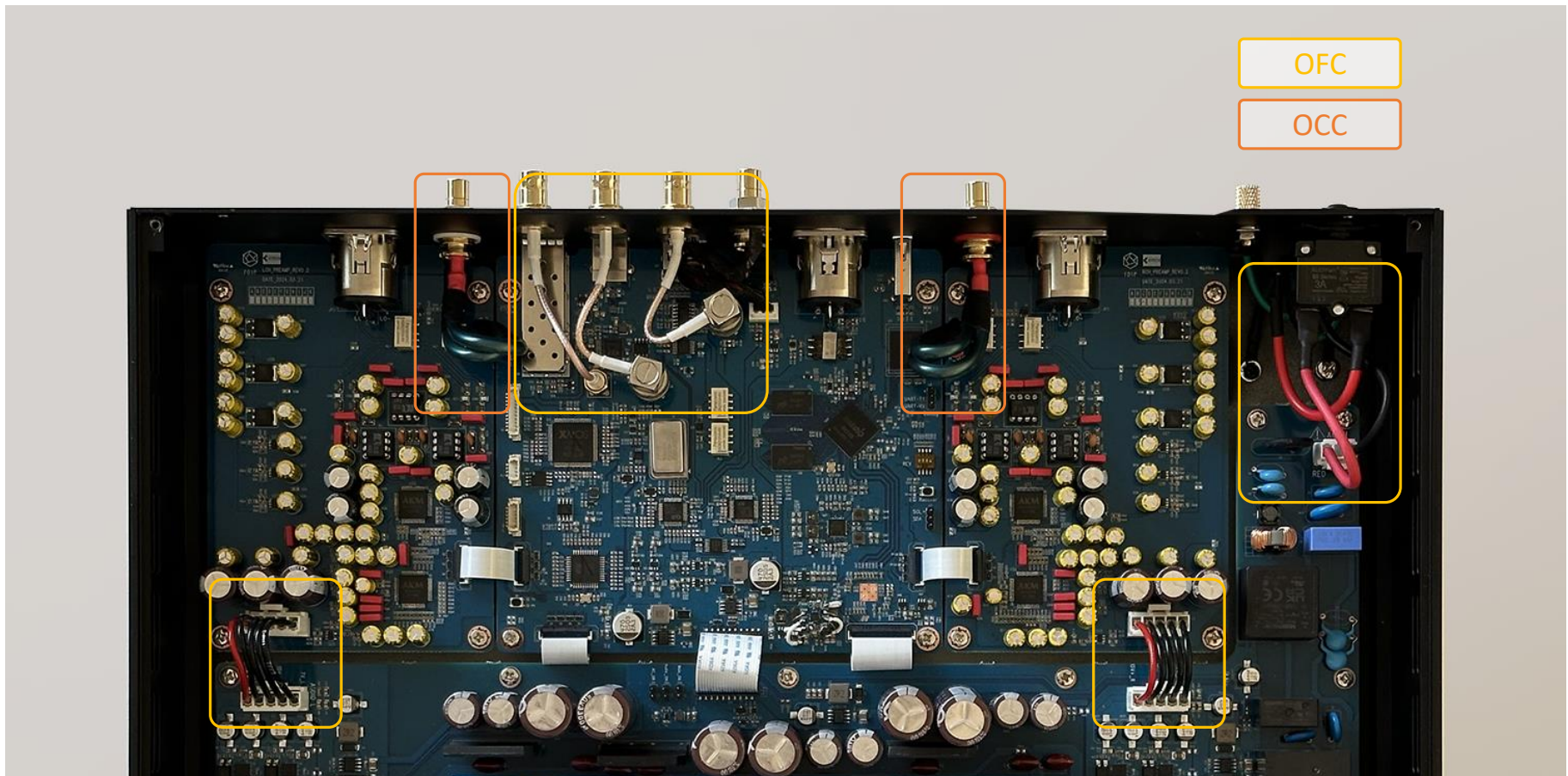

# High-Precision OCXO Clock

The high-precision OCXO mounted on the RD160 increases the accuracy of digital inputs and provides more precise clock signals. OCXO is the most accurate and stable clock in use today and is unaffected by temperature changes. Conventional crystals have a tendency to vibrate differently depending on temperature, which may cause jitter in audio signals. On the other hand, OCXO clocks suppress jitter by maintaining a constant temperature at all times, producing stable and precise clock signals.

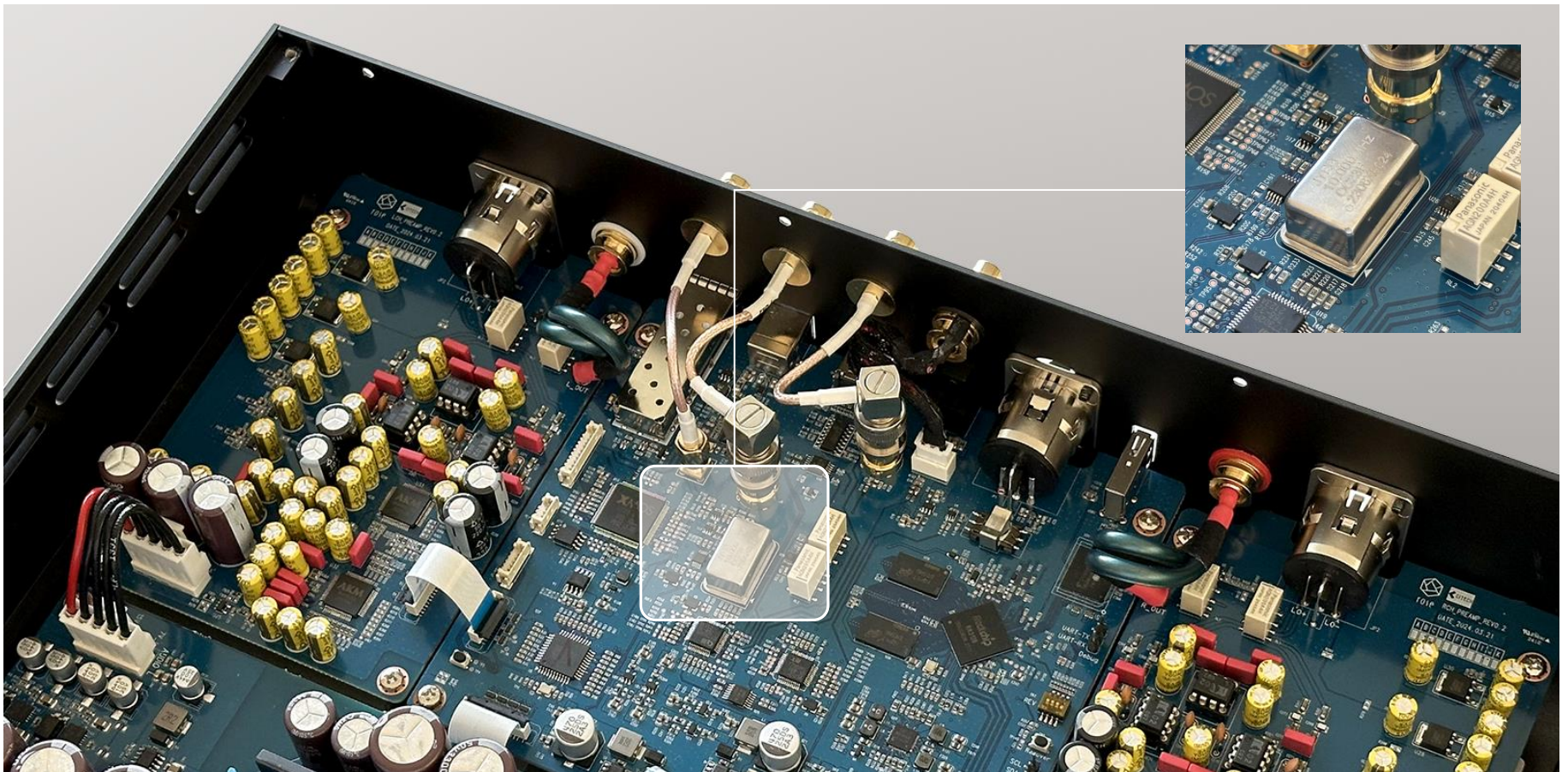





## 03 Feature

## Pre-Out Level Setting

The maximum allowable input voltage value of the amplifier varies depending on the manufacturer and model. If the output voltage of the source device exceeds the maximum allowable input voltage, clipping occurs, which causes sound distortion. The RD160 offers a wide range of pre-out level options from 1 to 9 V, ensuring clean, clipping-free sound, and stable compatibility with all existing amplifiers. By disabling this function, you can adjust the level with the knob, allowing you to connect the RD160 directly to a power amplifier without a separate preamplifier.

# Upsampling & Filters

The RD160 offers a variety of options. For upsampling, it provides four options (bypass, to PCM, to DSD, and upsampling) and supports up to 32 bit / 768 kHz for PCM and up to DSD512 for DSD. In addition, six digital filters with different impulse responses are provided, allowing the user to select according to their preference. These two functions can be easily set with the buttons on the left side of the front panel and are reflected on the hidden screen without delay.



## Optical USB

The SFP USB with optical conversion function completely blocks digital noise generated from the source device. HiFi ROSE's RS130 supports SFP USB connection and can transmit pure data in the cleanest and most noise-free manner.



Fiber Optic USB

## External Master Clock Input

The audio source requires a master clock input that outputs audio data synchronized with the master clock. By using the master clock, jitter caused by optical, coaxial, AES/EBU, and USB connections from audio sources to the DAC is eliminated, and further supports perfect synchronization between devices according to the usage environment.





## Dedicated Remote Control

Using the included dedicated remote control, you can conveniently control the various functions of the RD160 even from a distance.

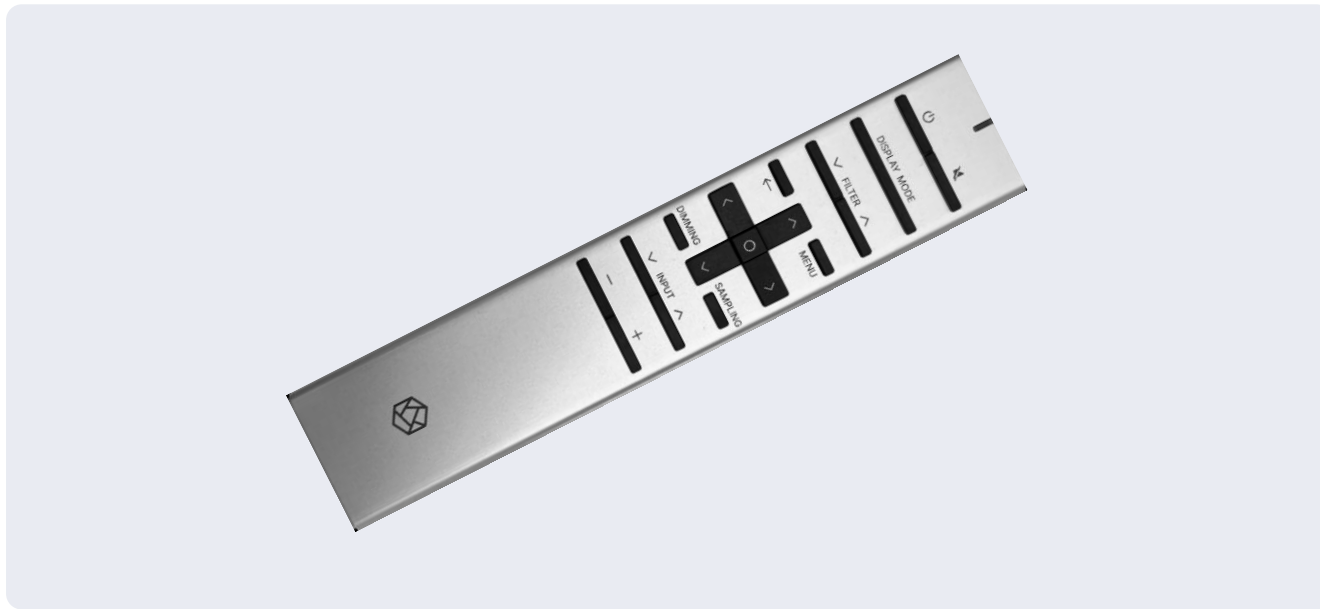



04

# Appearance

# Appearance



**Black**



**Silver**





05

# Specification

# Specification

## Benchmark

<b>Input Sensitivity</b>	<b>0dB 1kHz</b>
<b>Output Impedance</b>	<b>300Ω</b>
<b>Output Voltage</b>	<b>4.5Vrms(RCA), 9Vrms(XLR)</b>
<b>Total Harmonic Distortion</b>	<b>0.005%(RCA), 0.005%(XLR) (1kHz 0dB)</b>
<b>Signal-to-Noise Ratio</b>	<b>124dB(RCA), 124dB(XLR)</b>
<b>Residual Noise</b>	<b>0.3mV(RCA), 0.4mV(XLR)</b>
<b>Stereo Crosstalk</b>	<b>-124dB(RCA), -124dB(XLR) (1kHz 0dB)</b>
<b>Frequency Response</b>	<b>10Hz ~ 20kHz (-0.3dB) 10Hz ~ 50kHz (-1.5dB) 10Hz ~ 73kHz (-3.0dB)</b>

## Sampling Rate

<b>PCM</b>	<b>8kHz~768kHz(8/16/24/32bit per Sample)</b>
<b>DSD</b>	<b>DSD64(2.8MHz)/DSD128(5.6MHz)/DSD256(11.2MHz)/ DSD512(22.6MHz)</b>

# Specification

## Technical Specifications

<b>DAC</b>	<b>2 x AK4499EXEQ + 2 x AK4191EQ (AKM)</b>
<b>Power Supply</b>	<b>3 x Independently Customized Reference Linear Toroidal</b>
<b>CPU</b>	<b>RK3128 Quad core Cortex-A7mp</b>
<b>Memory</b>	<b>DDR3 1866Mhz 1GB</b>
<b>Flash Memory</b>	<b>8GB eMMc</b>
<b>Oscillator</b>	<b>High Precision OCXO clock</b>

## Input Section

<b>Digital Input</b>	<b>USB SFP Module - PCM 32bit/768kHz, DSD512(22.6MHz) USB 2.0 Type-B - PCM 32bit/768kHz, DSD512(22.6MHz) HDMI I2S - PCM 32bit/768kHz, DSD512(22.6MHz) Coaxial RCA - PCM 32bit/384kHz, DSD128(5.6MHz) Coaxial BNC - PCM 32bit/384kHz, DSD128(5.6MHz) Optical - PCM 32bit/192kHz, DSD64(2.8MHz) AES/EBU - PCM 32bit/384kHz, DSD128(5.6MHz)</b>
<b>External Clock</b>	<b>BNC 75Ω(10MHz), SMA 50Ω(10MHz)</b>

# Specification

## Output Section

<b>Analog Output</b>	<b>Unbalanced, Balanced</b>
----------------------	-----------------------------

## Features

<b>Pre-out Level</b>	<b>1V~9V</b>
<b>PCM Filter</b>	<b>Sharp SharpSlow Short Sharp (default) Short Slow Super Slow Low Short</b>

## Power

<b>Input Voltage</b>	<b>AC110V-120V~, 220V-240V~, 50/60Hz</b>
<b>Power Used During Standby</b>	<b>0.3W</b>
<b>Power Used During Playback</b>	<b>30W</b>

# Specification

## Environmental Specifications

---

**Operating Temperature** 0~40°C

---

**Storage Temperature** -10~50°C

---

## Design Specifications

---

**Display** 2 x Polycarbonate AMOLED hidden screen (MIPI-DSI)

---

**Size** 430(W) x 330(D) x 88(H) mm

---

**Weight** 10kg

---

**Material** Solid Aluminum / Rust-proof Steel

---

**Finishing Material** Silver, Black

---

**IR** 38kHz IR Receiver

---



06

# Connectivity

# Connectivity

## < RS130 / Transport >

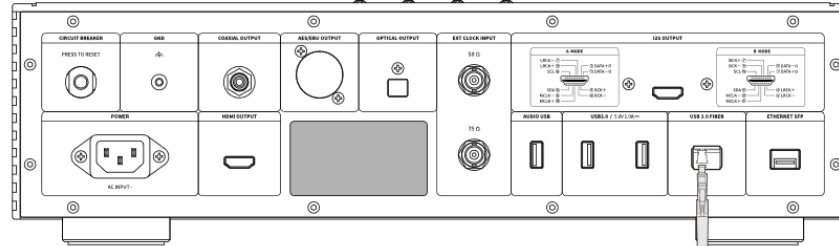

## < RD160 / DAC >

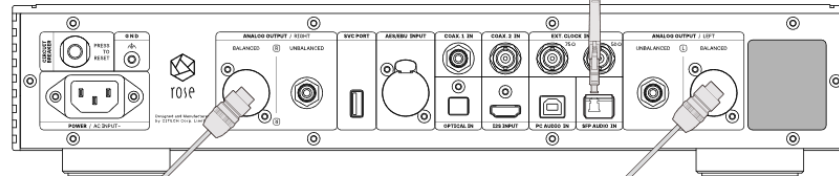

## < RA180 / Int. Amp >

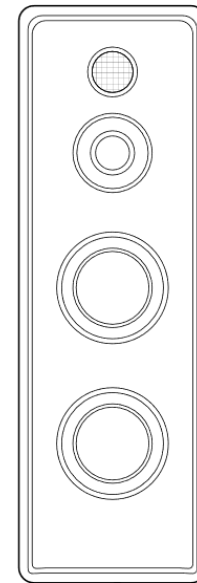
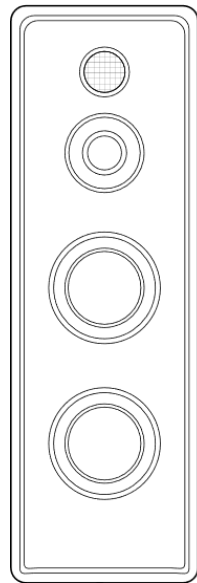
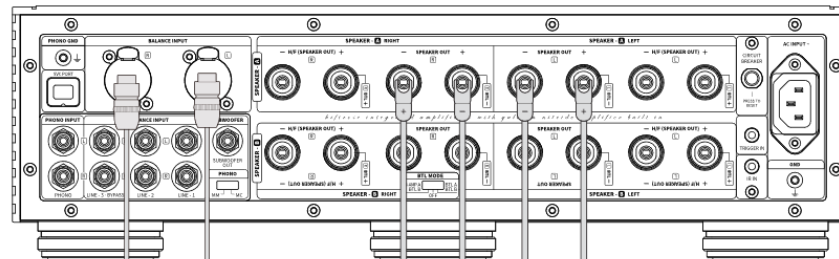

SFP Cable

InterConnect

Speaker Cable

# RD160

Absolute True Fidelity DAC

